

# Pneumatic Vibrator Manual



## Installation, Manual & Maintenance

The Cleveland Vibrator Company's line of industrial vibrators and material flow aids feature a wide variety of force ranges, construction types in air-powered (pneumatic) piston vibrators, hammers, knockers and rappers, turbine and ball vibrators for handling material flow challenges from a few pounds to over 100 tons in bins, hoppers, railcars, trucks, chutes, feeders, filters, screeners, packers, parts tracks and more.

### WHAT'S INSIDE

- Vibrator placement and mounting overview
- Installation guidance so you can plan ahead
- Component maintenance
- Operational instructions for each pneumatic model





## TABLE OF CONTENTS

Getting Started Check List .....	2
Installation .....	3
Welding .....	4
Air Prep & Plumbing .....	5 - 6
Model Operation Information .....	7
Piston Vibrators .....	7
Single Impact Air Knocker .....	8 - 9
Vacuum Mounted Vibrators .....	10 - 11
UH Portable Piston Vibrators .....	12
Miniature Piston Vibrators .....	13
Spring Activated Vibrators .....	13
Turbine Vibrators .....	14
Ball Vibrators .....	15
Maintenance Checks .....	16 - 17
Bolt Torque Chart .....	18
Troubleshooting .....	19
Warranty .....	19
Repair Services .....	19

## A NOTE FROM THE CLEVELAND VIBRATOR COMPANY

Thank you for purchasing pneumatic vibrators from the Cleveland Vibrator Company. Properly sized and installed pneumatic vibrators ensure better material flow through bins and hoppers.

Please review all installation, maintenance, operation, and model specific information carefully before use. If any assistance is required, do not hesitate to call our sales department with questions: **1.800.221.3298**



## BEFORE YOU GET STARTED CHECKLIST

### INSTALLATION

- You know where you're installing the unit(s)
- You know proper welding techniques
- You have safety cables ready

### OPERATION

- Air prep components are present
- Plumbing procedures have been reviewed
- Air pressure doesn't exceed 80 PSI

### KNOW YOUR VIBRATOR TYPE

- Impact or Air Cushioned Piston Vibrator
- Single Impact Air Knocker
- Spring Activated Vibrator
- Miniature Piston Vibrator
- Turbine Vibrator
- Ball Vibrator

### MAINTENANCE - Refer to page 5

- Lube & filter checks
- Tightened up the bolts
- Gasket checks
- Port protector checks

# Installation



## KEY CONCEPTS

- Vibrators have a ~5 ft. radius of influence on material and structure
- Vibration transfers better through curves than through corners
- When in doubt where to place a vibrator, **think about where your problem point is** and make sure vibration gets to it
- Be aware of rigid structural elements

## CHUTE DISCHARGE

The vibrator is mounted every 8 to 10 feet along the chute. Do not install vibrators more than 4 ft. from the end point of the chute.

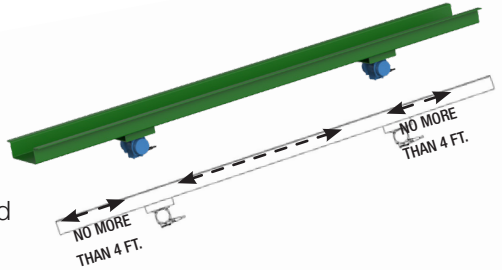

## CONICAL HOPPERS

Mount the vibrator on the hopper wall 1/3 the length of the sloped wall from the discharge. Should a second vibrator be necessary, it should be mounted opposite and approximately 1/4 way up the sloped wall. For large hopper applications requiring three vibrators, mount the third vibrator 1/2 way up the sloped wall.

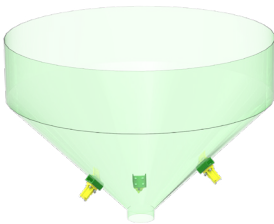

## RECTANGULAR & SQUARE HOPPERS

Mount is similar to conical hoppers on the centerline of one side. A second vibrator may be required if complete cleaning of all corners and sides is desired. Should a second vibrator be necessary, it should be mounted opposite and approximately 1/4 way up the wall. **Two (2) units work best for full corner clean out in bins and hoppers.**

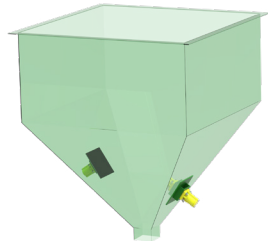

Not seeing your bin or hopper type? Ask about our Industrial Vibrator Sizing Guide!

# Proper Welding Techniques

## KEY CONCEPTS

- Never continuously weld
- Leave the corners free of weld
- The thickness of the weld should be at least as thick as the minimum thickness of either the bin wall or the mounting channel **For example:** if welding our SMP-2 on a 1/4" thick bin wall, use a weld that is at least 1/4" thick
- It is the responsibility of the welder to know the thickness of the bead and the penetration of the weld into both the channel and the bin wall. Penetration is critical. Too deep, the weld will go through the bin wall. Too shallow, the mounting channel hopper joint will fail
- It is suggested to have an equal 1:1 ratio of weld bead to gap between welds. **For example:** if an SMP-2 is being installed, we suggest 2" beads then 2" gap then 2" bead then 2" gap, etc.

**MIG, or also known as GMAW, welding is the preferred method.** It is recommended to use flux core wire for the MIG weld, as it is ideal for welding to surfaces such as mild steel and stainless steel.

When stitch welding a cast iron bracket to a mild steel vessel, preheat casting (500°F to 1200°F) before beginning the welding job. A rod similar to Ni55 is suggested to be used when MIG welding the bracket to the vessel.

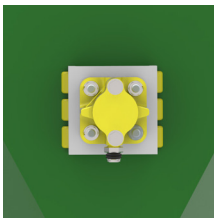

Proper Welding of a Short Mounting Channel

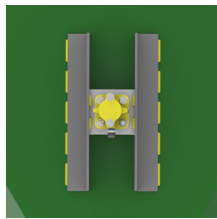

Proper Welding of a Short Mounting Channel with Angle Runners



Proper Welding of a Short Mounting Channel with Stiffener Plates

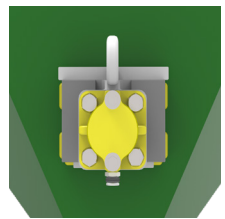

Proper Welding of a Railcar Style Female Bracket

**SAFETY CABLES** - Eyelets have been provided in the body casting of the pneumatic vibrator for safety cable hookup. A safety cable of suitable strength for the weight of the vibrator should be provided. It should be installed in the eyelet of the vibrator and on the location of the bin or hopper wall above the vibrator. **\*This is an important safety feature that should not be overlooked.**

# Air Prep & Plumbing

## IMPORTANT INSTALLATION NOTES

- The air prep (FRL/FR) should be within 10 ft. of the vibrator & installation height should be equal to or above the vibrator location to allow for best lubricant flow
- The vibrator valve (ball or solenoid) must be installed within 10 ft. of the vibrator and have quick on/off capabilities to provide quick burst of air to the vibrator for the necessary air burst to start the piston or ball or impeller
- The timer (which is optional) can be tied into the solenoid valve, however their Voltages MUST be the same

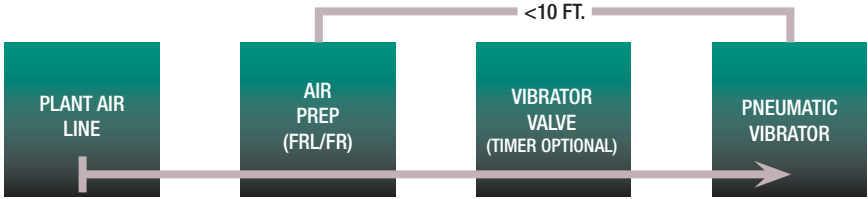
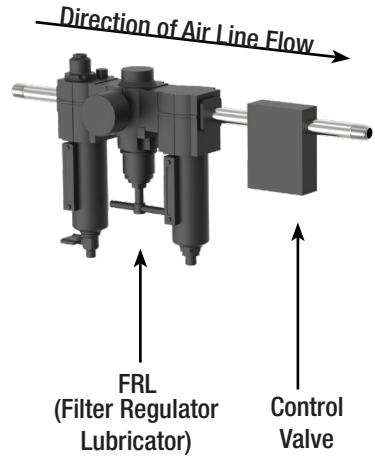

## CONTROL THE PNEUMATIC VIBRATOR

For pneumatic vibrators, short bursts, 5 to 30 seconds, of operation are often times more effective than continuous use. While many of Cleveland Vibrator's air vibrators are continuous duty units, they do not necessarily need to be operated this way. The most efficient ratios of air consumption to force output of the vibrators are found when the vibrator is operated between 20-80 PSI.

**Do not operate vibrators against closed hopper gates or valves.**



# Air Prep & Plumbing



## COMPONENTS CHECK

### FILTER (F)

The purpose of the filter is to remove moisture as well as damaging particles before they enter the system. It is essential to maintain a clean filter element by periodic washing.

### REGULATOR (R)

The frequency and force output of the vibrator can be regulated by controlling the line pressure with the regulator. Complete installation and operating instructions can be found inside the lube-control unit packaging.

### LUBRICATOR (L)

Lubricating the air line limits the chance of the piston seizing inside the body of the vibrator or helps the steel ball move within the ball vibrator. It is suggested to use Cleveland Vibrator's Vibra-Lube or a similar 10W/NR lubricant. One (1) drop of oil per minute for every 10 CFM is recommended.

\*If the cap or body is stamped "COATED," the unit is treated with a coating that extends life when operated without lubrication. The vibrator can still be lubricated if desired, but it is not necessary.

### VALVE

A quick acting valve is required to operate the vibrator. The Cleveland Vibrator Company has manual (hand and knee) and electrically operated valves. The pipe thread intake size of the operating valve should be the same as the vibrator pipe thread intake connection size. The valve should be installed within 10 feet of the vibrator.

### OPERATING MULTIPLE VIBRATORS ON ONE VALVE

If your operations require multiple vibrators to operate on one valve, appropriate adjustments must be made to size of the NPT inlet. Let us walk you through finding the correct size NPT inlet needed with this simple equation:

#### INLET SIZE X $\sqrt{\text{NUMBER OF VIBRATORS OPERATING ON 1 VALVE}}$

**For example:** Let's say we are trying to operate (3) 1350 VMSAC on one valve. The 1350 VMSAC has a 1/2" NPT inlet. So, you'd take  $1/2 \times \sqrt{3}$  to determine the size of the ports required on the valve. The answer here .866 which means a 1" NPT valve would be required to handle all (3) 1350 VMSAC from the same valve. The standard valve to operate (1) 1350 VMSAC is 1/2" NPT.



# Piston Vibrators

VMS • VMR • VMSAC • VMRAC • PMA • C-1175  
FEP • VMRAC-EP



## BEFORE INSTALLATION

- Remove plastic plugs from inlet and outlet ports.
- Thread the port protector or muffler into the exhaust port
- Locate the mounting hardware
- Locate the base gasket (only if installing VMS or VMSAC model)

## OPERATION

### ON/OFF CYCLE TIMES

- For piston vibrators, short bursts, 5 to 30 seconds, of operation are often times more effective than continuous use.
- Air piston vibrators are continuous duty units, but not all applications require continuous vibration.
- The most efficient ratios of air consumption to force output of the vibrators are found when the vibrator is operated between 20-80 PSI.

### AIR PREP REQUIREMENTS

- Filter - required
- Regulator - required
- Lubricator - required\*



Extended Piston Vibrators feature a threaded, extended piston that can be installed with a channel mount directly to a hopper. **If the unit comes equipped with a bumper, the vibrator can be used for padded direct impact on the medium requiring vibration.**

\*If the cap is stamped "COATED," the unit is treated with a coating that extends life when operated without lubrication. Lubrication enhances the performance of the vibrator.

# Single Impact Air Knockers



## OPERATION

- Energize both electrical and pneumatic systems.
- Regulate air supply down to 40 PSI.
- Turn timer switch to ON.
- Gradually increase the line pressure, which will increase the force developed by the impactor. Arrive at the minimum line pressure that is required to successfully accomplish the impactors' task. Do not operate the impactor at a higher line pressure than is necessary to do the required job.
- By adjusting the timer, arrive at the longest interval possible between impacts that satisfy the job requirement. Increasing the time between impacts prolongs the life of the impactor and conserves air.
- Double check all electrical and pneumatic connections to be certain all systems are functioning properly.

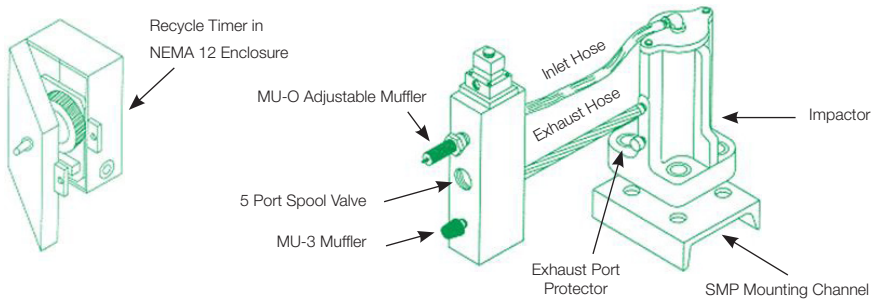

**NOTE:** Install gasket between mounting channel and impactor.

**IMPORTANT:** The number five port on the spool valve for 1125, 1200, 1300, 1350 and 1400 SI models have been specially modified with an adjustable muffler to restrict the exhausting air passing through it and thereby create a back pressure on the return stroke of the piston. The restricted port and the resulting back pressure are necessary to slow down the piston and prevent it from striking the top cap too hard. If the impactor is allowed to operate without a restriction, the piston will hit against the cap with the same energy as on the impact stroke, which could result in equipment damage or personal injury. For 1500 SI models and larger, contact sales for more information.

**The port restriction has been installed at the factory and will not come out under normal use and operation. At no time should an operator attempt to remove the restriction for any reason.**

# Single Impact Air Knockers



## MUFFLER & PORT PROTECTORS

Provided with the impactor and spool are (1) type MU-3 muffler, (1) MU-0 adjustable muffler, and (1) port protector. The port protector should be securely fastened to the lower side port of the impactor.

For 1125, 1200, 1300, 1350 and 1400 SI models, the MU-3 muffler is inserted into the 3 port. The MU-0 adjustable muffler is inserted into the number 5 port of the spool valve. For 1500 SI models and larger, contact sales for more information.

## HOSE CONNECTION • IMPACTOR TO SPOOL VALVE

It is recommended that the 5-port spool be mounted within five feet of the impactor. The distance should NEVER exceed ten feet. Proper functioning of the SI requires that only hoses of the proper diameter and wall strength be used. If factory supplied hose is not being used, consult the Cleveland Vibrator Company for specifications on the proper hose.

The larger diameter hose is connected between the inlet port located in the cap of the impactor and the number 4 port for the 1125, 1200, 1300, 1350 and 1400 SI models. The smaller diameter hose is connected between the upper side port of the impactor (refer to illustration) and the number 2 port on the spool valve. The main air supply line should then be connected to the number 1 port on the spool valve. For 1500 SI models and larger, contact sales for more information. **Be certain that all hose connections are securely fastened and do not leak.**

## TIMER

The standard adjustable timer as supplied by Cleveland Vibrator Company is a solid state timer in a NEMA 12 enclosure. One segment of the time cycle allows the operator to adjust the duration of time the impactor impacts. The second segment of the time cycle controls the length of time between impacts.

**On Time** • 1 to 100 Seconds (2-4 sec. recommended)

**Off Time** • 1 to 100 Seconds (3-5 sec. or greater recommended)

**NOTE:** The connection of the timer to the power source as well as the connection of the time to the solenoid head of the spool valve should only be performed by a qualified electrician who is totally familiar with all local codes.

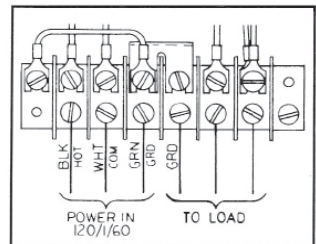

# Vacuum Mounted Vibrators

## PISTON • TURBINE



### BEFORE INSTALLATION

- Check all hose connections on the assembly
- Confirm that the mounting location of the vibrator is flat and smooth
- Unit can stick to rusty or wet surfaces

### OPERATION

#### ON/OFF CYCLE TIMES

- Vacuum generator must be engaged first before vibrator operation
- Short burst operation, typically between 5 to 30 seconds, is optimal for vacuum mounted units
- Turn off the vibrator unit prior to removal of the vacuum cup from the mounting location

#### AIR PREP REQUIREMENTS

- Filter - required
- Regulator - included
- Lubricator - not required

# Vacuum Mounted Vibrators

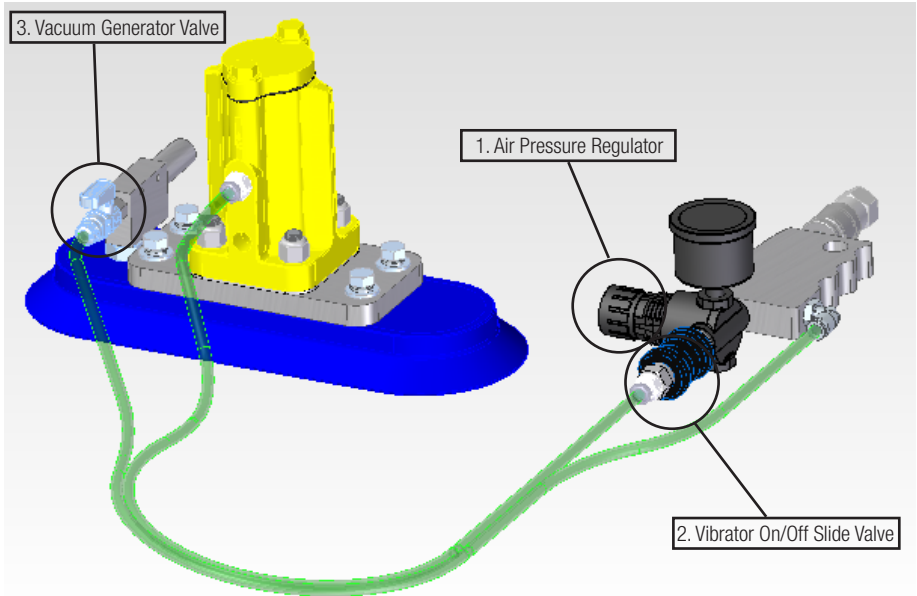

There are a few steps to follow in order to operate this model properly:

- Attach supplied hosing to controls and vibrator unit
  1. Elbow fitting on controls attaches to the ball valve on the vacuum cup
  2. Slide valve fitting on controls attaches to the fitting on the vibrator
- Bring in 1/2" male fitting on air supply line to connect to the 1/2" female push-to-connect fitting supplied with the entire assembly
- One air supply is connected, there are three controls on the assembly to use:
  1. Air pressure regulator to control PSI that runs through the air circuitry
  2. 3-way/2-position shuttle slide valve for on/off control of vibrator
  3. Half turn ball valve for vacuum generator
- After the air supply is safely connected and turned on, the air pressure should be regulated between 0-80 PSI
- Next, turn the ball valve on the top side of the vacuum cup 90° to initiate the suction process
- Once the vacuum cup is secured to the mounting location, slide the shuttle valve from the off position (closer to the regulator) to the on position. The vibrator will start to operate immediately

Units have the best chance of sticking to a clean and smooth mounting surface. They have been used on rusty exterior bin walls and wooden forms/molds.

# UH Portable Piston Vibrators



## BEFORE INSTALLATION • OPERATION • AIR PREP

- **1-1/4" UH** - Refer to SA-EP Model information located on page 10 of this manual
- **1-1/4" UHVM** - Refer to VMS Model information located on page 7 of this manual
- **2" UHVM** - Refer to VMS Model information located on page 7 of this manual

## MOUNTING INSTRUCTIONS

*The UH Style Vibrator must be used with a female bracket for correct operation of the unit. Improper mounting will result in significantly reduced life of the product out in the field.*

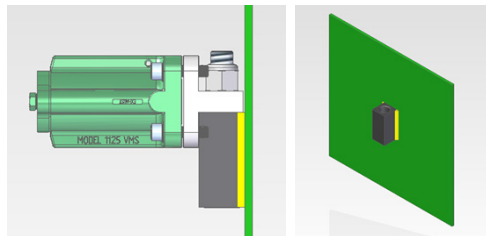

### Mounting Instructions:

- Weld female bracket to hopper or to the area you desire vibration to be present
- \*Do **NOT** weld the corners of the bracket
- Insert the pin into the female bracket

FIGURE 1

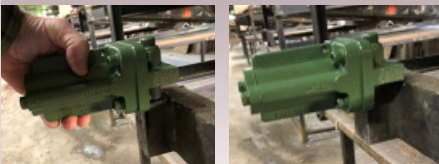

Field Photo of proper installation of female bracket for UH Style Vibrator

FIGURE 2



Field Photo of improper installation and operation results

# Mini Piston & Spring Activated

VM • SA-EP • SAM • ACM • CBS



## BEFORE INSTALLATION

- ACM & SAM - Thread the port protector into the exhaust port
- VM - Thread muffler into the exhaust port (if purchased with vibrator)
- SA-EP - Exhaust protection is built into the unit
- Locate the mounting hardware

## OPERATION

### ON/OFF CYCLE TIMES

- Rated for intermittent duty
- For piston vibrators, short bursts, 5 to 30 seconds, of operation are often times more effective than continuous use.
- The most efficient ratios of air consumption to force output of the vibrators are found when the vibrator is operated between 20-80 PSI.

### AIR PREP REQUIREMENTS

- Filter - required
- Regulator - required
- Lubricator - required\*

\*If the cap is stamped "COATED," the unit is treated with a coating that extends life when operated without lubrication. Lubrication enhances the performance of the vibrator.

### SPECIAL NOTE REGARDING VM-25 & VM-38 MODELS:

- VM-25/38 recommended operation is 5-30 seconds per 1-5 minutes of operation
- Best suited for free flow of materials from small bins or hoppers with a wall thickness minimum of 28 gauge and maximum 2 cubic feet (57L) total capacity
- The most efficient ratios of air consumption to force output of the VM vibrator models are found when the vibrator is operated between 60-80 PSI

# Turbine Vibrators

CVT • CVT-P • CVT-S • CVT-A



## BEFORE INSTALLATION

- Thread the port protector or muffler into the exhaust port
- Locate the mounting hardware

## OPERATION

### ON/OFF CYCLE TIMES

- For turbine vibrators, short bursts, 5 to 30 seconds, of operation are often times more effective than continuous use.
- Turbine vibrators are continuous duty units, but not all applications require continuous vibration.
- The most efficient ratios of air consumption to force output of the vibrators are found when the vibrator is operated between 20-80 PSI.
- **Please allow 10 seconds between each on/off cycles. Bearing must come to a complete stop before turning the vibrator on again.**

### AIR PREP REQUIREMENTS

- Filter - required
- Regulator - required
- Lubricator - not required

## INSTALLATION

Units should **ONLY** be mounted vertically.

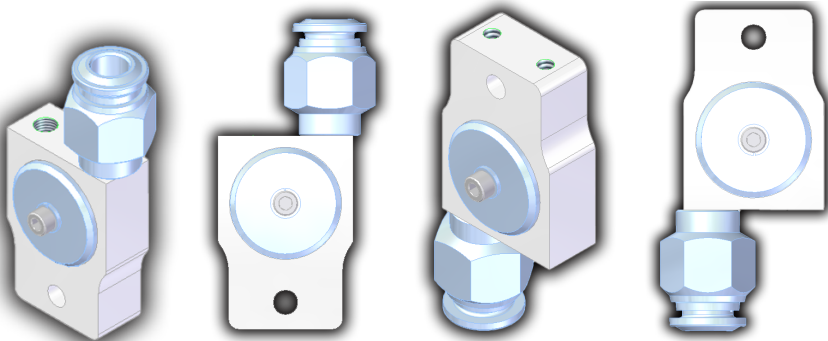

\*\*\*CVT-P-1, CVT-P-1M, CVT-S-1M = 60 PSI MAX



# Ball Vibrator

VBB • VBC • VBD



## BEFORE INSTALLATION

- Thread the port protector or muffler into the exhaust port
- Locate the mounting hardware

## OPERATION

### ON/OFF CYCLE TIMES

- For ball vibrators, short bursts, 5 to 30 seconds, of operation are often times more effective than continuous use.
- Ball vibrators are continuous duty units, but not all applications require continuous vibration.
- The most efficient ratios of air consumption to force output of the vibrators are found when the vibrator is operated between 20-80 PSI.

### AIR PREP REQUIREMENTS

- Filter - required
- Regulator - required
- Lubricator - not required but enhances performance

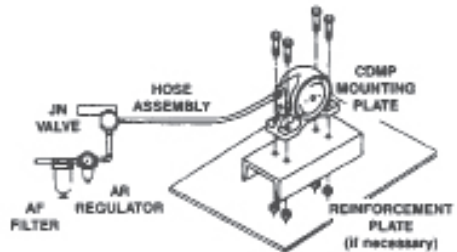
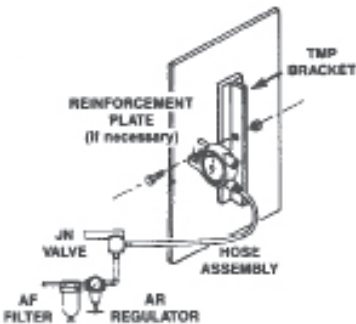

# Maintenance Checks



## AIR PISTON VIBRATORS

### LUBRICATION

Check lubricator with some frequency. If operating continuously, check and/or refill every 1-3 weeks. If used intermittently or infrequent, schedule on a 1-4 month basis. It is suggested to use Cleveland Vibrator's Vibra-Lube or a similar 10W/NR lubricant. One (1) drop of oil per minute for every 10 CFM is recommended. The use of internal coating in the vibrator can reduce or remove the need for lubrication. Coatings without the use of lubrication, will typically wear out faster than a coated or uncoated piston vibrator that is properly lubricated.

### FILTER MAINTENANCE

The filter is there to protect incoming air by collecting potential contaminants. Check the filter with some regularity to ensure the collected contaminants aren't preventing proper operation of the filter or proper air flow. Inspection schedule should be set on the same schedule as the Lubricator.

### SPRING

Models that require springs (and models from other manufacturers that require them) will wear out and break over time.

### GASKETS

VMS, VMSAC, VMR, VMRAC, and SI models all use gaskets to create a seal. Inspect seals on the same schedule as lubrication for any signs of leaking or cracking, especially if in a hot environment. Gaskets typically fail slowly over time, with vibrator performance reduced rather than immediately stopped.

### SEAL RINGS

SI units utilize sealing rings on the piston. Lubrication helps keep their life extended. Like gaskets, they will eventually wear or break. A broken seal ring will stop the SI. The seal rings are internal, a frequent inspection schedule is not viable.

### PISTON/BORE

Over time, the friction of the piston and bore and/or contamination entering the unit will wear the unit to need replacement. In addition to the proper lubrication and filtering practices (and protection of exhaust port), consider cleaning the piston and bore. This can be done on an infrequent maintenance schedule (such as annually) or as a troubleshooting step should abnormal performance begin to happen. If the unit is an SI unit, this could also be a good time to inspect or replace the seal rings.

# Maintenance Checks



## TURBINE VIBRATORS

### LUBRICATION

Turbine vibrators do not require any lubrication, as they use permanently lubricated sealed bearings.

### FILTER MAINTENANCE

It is recommend to filter the air, as contamination can lead to fast wear and an early demise. Similar to a piston vibrator, if the unit is operated continuously, check and/or refill every 1-3 weeks. If the unit is used intermittently or infrequent, schedule on a 1-4 month cycle.

### BEARING

The bearing inside the turbine vibrator is the only designed wear part. No inspection is required as it will have consistent performance right up until it fails.

## BALL VIBRATORS

### LUBRICATION

Ball vibrators do not require any lubrication. Expect longer operational life if the unit is properly lubricated.

### FILTER MAINTENANCE

Ball vibrators are the most resilient to contamination of all pneumatic vibrator styles. But, a filter will enhance life, as contamination will eventually impact performance. Similar to a piston vibrator, if the unit is operated continuously, check and/or refill every 1-3 weeks. If the unit is used is intermittently or infrequent, schedule on a 1-4 month cycle.

### BALL/RACES/CAPS

Eventually, the ball and what it rides on (either the caps on the Vibraballs or hardened races in other models) will wear to a point of no longer being effective. The wear is continuous and will gradually decrease the performance slowly over life. It is recommended to inspect every 6-12 months to check if the units are running with higher pressure and/or higher CFM.

**CHECK YOUR NUTS & BOLTS ON ALL MODEL INSTALLATIONS.**

# Bolt Torque Chart



Bolt diameters must correspond to the bolt hole size. Vibration will tend to loosen bolts and nuts during initial few hours of operation.

Diameter & Threads Per Inch	Stress Area in Square Inches	Tensile Strength Minimum KSI	Proof Load in Pounds	Clamp Load in Pounds	Torque Dry in Foot Pounds*	Torque Lubricated in Foot Pounds**
1/4 • 20	.0318	120	2,700	2,020	8	6.3
1/4 • 28	.0364	120	3,100	2,320	10	7.2
5/16 • 18	.0524	120	4,450	3,340	17	13
5/16 • 24	.0580	120	4,900	3,700	19	14
3/8 • 16	.0775	120	6,600	4,950	30	23
3/8 • 24	.0878	120	7,450	5,600	35	25
7/16 • 14	.1063	120	9,050	6,780	50	35
7/16 • 20	.1187	120	10,100	7,570	55	40
1/2 • 13	.1419	120	12,100	9,050	75	55
1/2 • 20	.1599	120	13,600	10,200	85	65
9/16 • 12	.1820	120	15,500	11,600	110	80
9/16 • 18	.2030	120	17,300	12,950	120	90
5/8 • 11	.226	120	19,200	14,400	150	110
5/8 • 18	.256	120	21,800	16,350	170	130
3/4 • 10	.334	120	28,400	21,300	260	200
3/4 • 16	.373	120	31,700	23,780	300	220
7/8 • 9	.462	120	39,300	29,450	430	320
7/8 • 14	.509	120	43,300	32,450	470	350
1 • 8	.606	120	51,500	38,600	640	480
1 • 14	.679	120	57,700	43,300	720	540
1-1/8 • 7	.763	105	56,500	42,300	790	590
1-1/8 • 12	.856	105	63,300	47,500	890	670
1-1/4 • 7	.969	105	71,700	53,800	1,120	840
1-1/4 • 12	1.073	105	79,400	59,600	1,240	930
1-1/2 • 6	1.405	105	104,000	78,000	1,950	1,460
1-1/2 • 12	1.581	105	117,000	87,700	2,200	1,640

**NOTE:** Torque Values For 1-3/4" Diameter Bolts Are The Same As 1-1/2" Diameter Values

\*Use these values if you do not lubricate the bolt.

\*\*Use these values if we supplied equipment with vibrator drive(s) attached.

**DO NOT REUSE LOCK NUTS**

# Troubleshooting



**If vibrator fails to operate, check the following as causes of failure:**

- Check all air connections (i.e. air supply entering exhaust port)
- Installation of operating valve more than 10 feet from vibrator
- Insufficient volume of air to maintain vibrator's operation
- Dirt or grit in vibrator assembly

**If problem still continues to exist after checking above causes contact the supplier.**

# Warranty Information



Cleveland Vibrator Company industrial vibrators are warranted for 6 months from the date of shipment, if the unit is installed and operated in accordance with the factory instructions. The warranty covers material defects and manufacturer's workmanship.

# Repair Services



**The cost of reconditioning generally runs approximately 50%-60% of the cost of a new unit and is covered by the same warranty as the new unit, if it is a Cleveland Vibrator Company unit.**

Cleveland Vibrator Company has its own repair department, staffed by experienced and qualified personnel. Both the air and electric repair departments provide quality reconditioning of all used and worn vibrators. We can also evaluate, repair or replace competitor vibrators. Units can be sent for a free evaluation.

A cost estimate, if repairable, will be provided in writing before repair work begins.



## FOR MORE INFORMATION

Call: Sales at 800-221-3298

Email: [sales@clevelandvibrator.com](mailto:sales@clevelandvibrator.com)

Buy Online: [www.clevelandvibrator.com](http://www.clevelandvibrator.com)

